

ACFR INSTALLTION GUIDELINE

Rev.5 Dec. 2024

1. Aluminum Conductor Fiber Reinforced

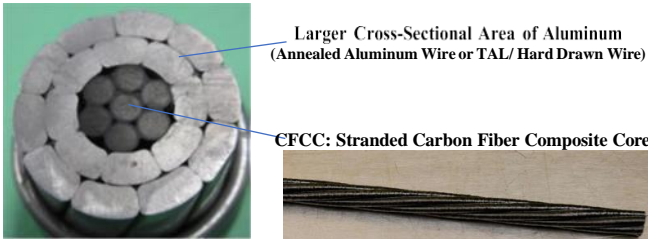

1.1. ACFR conductor uses a high-strength stranded composite core (Carbon Fiber Composite Cable: CFCC) which consists of carbon fibers and thermoset resin matrix. CFCC has 1/5 the weight and 1/12 the thermal expansion coefficient compared to conventional stranded steel wire. The reduced weight of the composite core and lower coefficient of thermal expansion allows the ACFR to carry up to twice the current of conventional conductors while lowering transmission losses.

Item	Characteristics	
	CFCC	Steel
Material	CFCC	Steel
Strands	7/2.6	7/2.6
Calculated Cross Section	mm ² 37.20	37.16
Outer Diameter	mm ² 7.8	7.8
Weight	kg/km 60.0	291.3
Tensile Load	kN 79.5	44.0
Elastic Modulus	N/mm ² 126,000	206,000
Thermal Expansion	10 ⁻⁶ /°C 1.0	11.5

Table 1: CFCC® & Steel core characteristics comparison

1.2. Stranded construction of the CFCC provides flexibility, structural redundancy and practical handling. Flexibility of the core translates into lesser chance of breaking the core which prevents re-work and saves time during installation process. Conventional ACSR installation technique can be used. Upgradation of tools required for installation of ACFR is minimum.

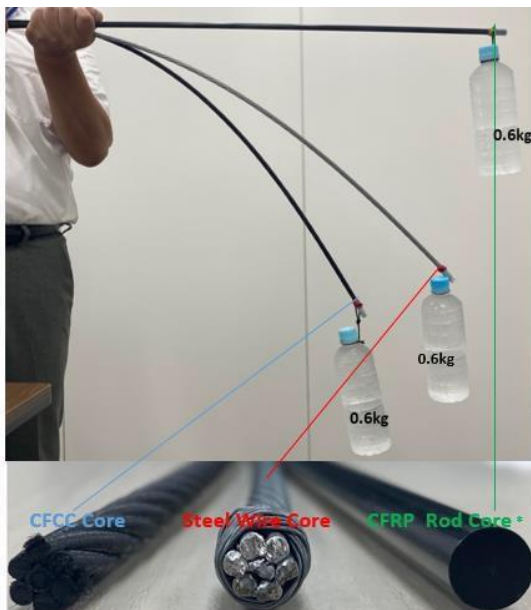

1.3. Cross sectional area of aluminum is increased by the trapezoidal wire which increases the transmission capacity and/or lowers ohmic losses. EC grade hard drawn aluminum wire or thermal resistance wire of Al-Zr alloy or EC grade annealed aluminum wire can be used for the conductive layers. Caution should be used to avoid damaging softer annealed aluminum by dragging or scratching the surface.

1.4. ACFR's maximum operation temperature is 180°C and 200°C for emergency.

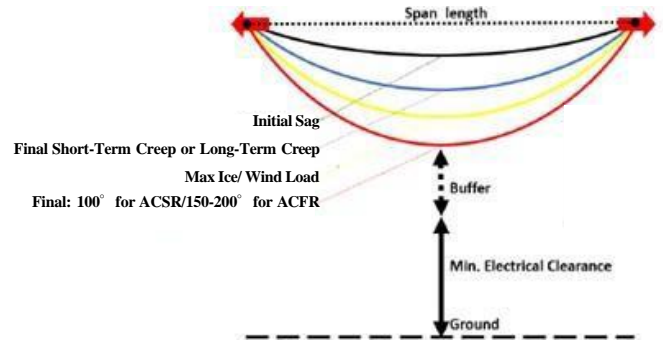

1.5. To avoid damaging the conductor, tension stringing method is recommended. **Extra care to control bend and twist shall be taken as well as ensuring proper splicing.** While steel strands are hard and can resist crushing loads, the CFCC core can sustain damage if the conductor is crushed. ACFR conductor is relatively flexible and can tolerate some abuse and round bending to some extent; however, care shall be taken to avoid local bending, twisting and crushing. Driving a vehicle across a cable, unsupported conductor end hanging down from conductor grip, sharp bending by hoisting or laying conductor over obstacle are examples of abuse that a steel core conductor might survive but might damage the composite core. It is okay to drape slack conductor across small roller but **it would not be acceptable if the bend were sharp and local and the conductor were under tension.**

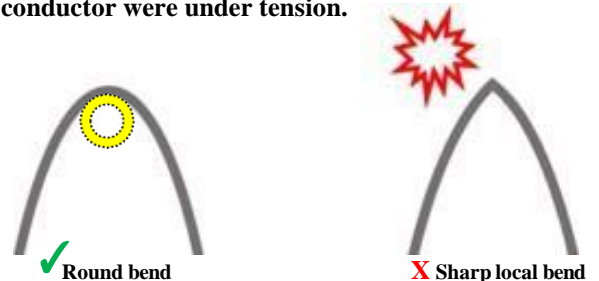

1.6. **Avoid excessive bending:** A steel strand will kink if it is bent, but it can be straightened with only moderate loss of strength. Each CFCC core is tested at the factory to ensure it can tolerate reasonable bending stresses during installation. Unlike steel strands, CFCC core strands do not yield or kink when bent past a safe diameter.

1.7. **Local bending should be avoided at all times.** It must be assured that safe margin is kept to the breaking point during all handling and installation. Care shall be taken to monitor, detect and report any event where the bending/twisting limit could have been exceeded. Exceeding the limits will result in distortion of aluminum layers. **Damaged conductor should be repaired and/or replaced.**

2 TRANSPORTATION AND BASIC HANDLING

2.1. Loading and unloading of ACFR drum should be performed in a manner that **the conductor drum remains in vertical position and the reel flanges are not damaged**. The drums should never be thrown from the truck during unloading, nor should they be moved by uncontrolled rolling. The drum should not be transported and/or stored on its side under any circumstances. The conductor ends should be fixed to prevent the conductor from slackening. All of the staves and/or safeguards should be maintained until the drums are set-up for immediate installation.



2.2. **Conductor should be stored away from direct heat and rain** as this would cause oxidation. Conductor surface would turn dark or black if oxidized. (however, is not a defect). The drums should be stored off the ground and the conductor ends should be sealed to prevent water penetration. It is always recommended to store drums inside warehouse.

2.3. **Conductor Oxidation / Staining.** Oxidation on the conductor can be caused by exposure of conductor to atmosphere which results from a chemical reaction between oxygen and aluminum. While it is normal for oxidation to form, the conductor must be brushed and cleaned properly in these areas prior to installing the hardware to ensure adequate metal-to-metal contact. (Also, a black "water stain" can appear on the conductor if the moisture accumulated on the conductor contains chemicals from the surrounding atmosphere and they have no adverse effect on the performance or service life of the conductor.)

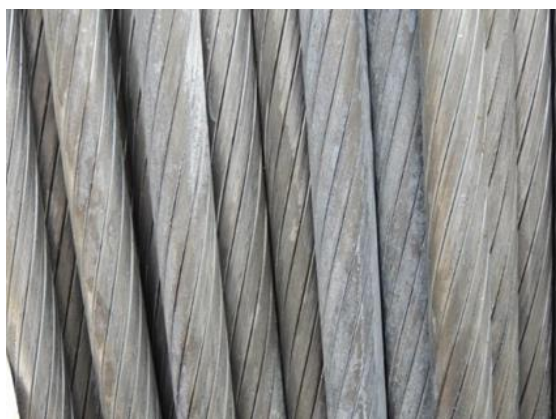

2.4. **A bending limit should be maintained at all times.** Assure that conductor does not bend more than allowable bend diameter of $40 \times$ conductor diameter at all times.



2.5. **Rewinding excess ACFR conductor** on its drum can be done manually or hydraulically with light back tension. Conductor should not bend, twist, rub or scrape on the flanges. **Assure that each wrap of the conductor does not cross over during rewinding** as the core might be damaged when it is paid out with back tension



3. PULL / TENSION SITE

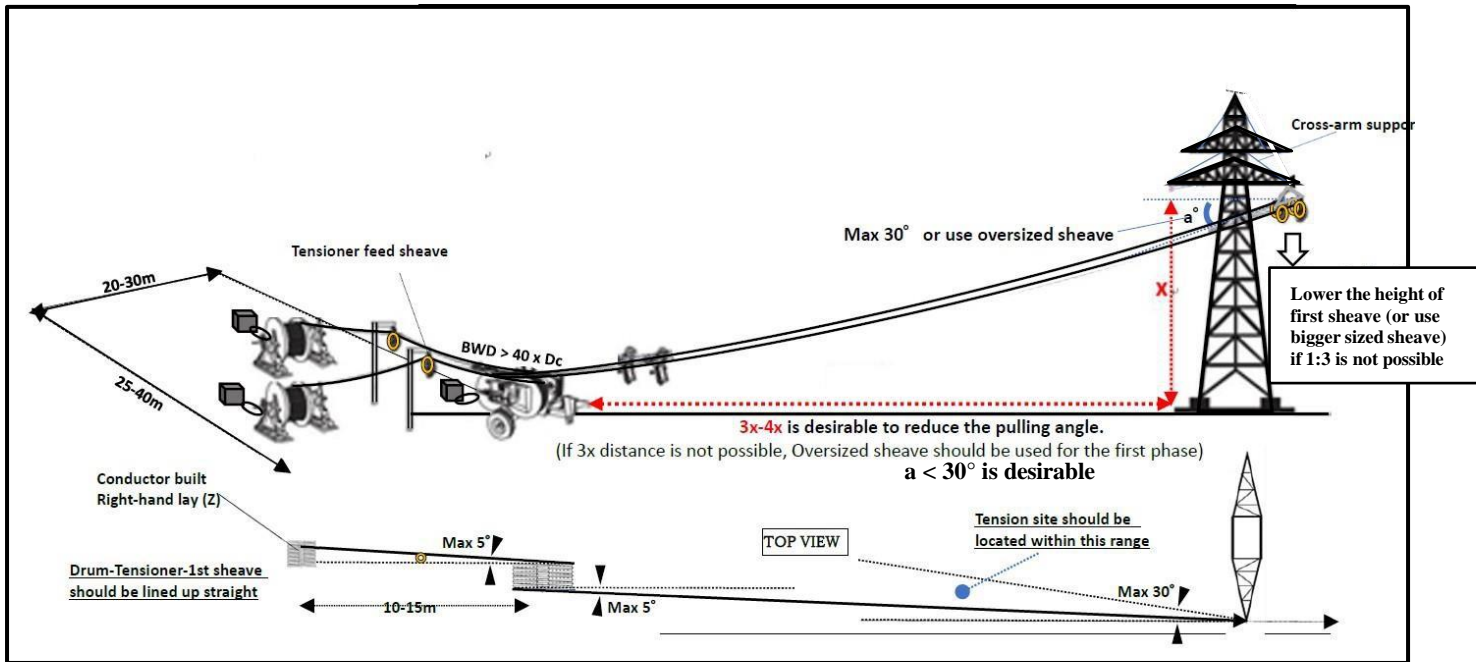

3.1. The pull/tension site should be selected considering the following:

- A) Distance and alignment from the 1st/last tower
- B) Availability of area to be used for setting up drums, puller/tensioner
- C) Accessibility for transportation by trucks
- D) Crossings and obstacles (rollers, scaffoldings, cradle method, safety net, clearance from energized lines)
- E) Number of sheaves (< 20 sheaves)
- F) Pulling tension and required clearance (pulling tension $\leq 10\%$ RTS of the conductor(s) and/or 50% of sagging tension)
- G) Pulling length (< 20 spans or 3 drums)

3.2. The puller and tensioner shall be positioned at a distance of **min. 3 times the height** of the connection point of the phase being strung which corresponds to an upwards conductor angle of about 20 degrees. This practice will limit the vertical load on the structure and also the conductor pressure on the first sheave by larger pulling slope. In case that this 3:1 rule is not achievable, larger or tandem sheave configuration at the first structure should be used according to the entering angle or the height of the first structure running block may be lowered.

3.3. The tensioner as well as the puller and the sheave at first/last structure shall be **aligned with the planned direction of pull**. Deviation in the direction of pull (α) shall not exceed 30°.

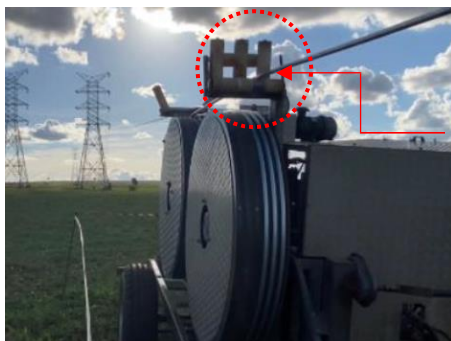

No Bending

3.4. Running grounds should be installed along two points in the pull: one between the reel stand or tensioner and the first structure, and the other between the puller and the last structure. Running grounds should be bonded to the established ground and free-wheeling not to cause surface abrasion or bird caging.

3.5. **DO NOT USE smaller than 40 x Dc Bullwheel** recommended diameter which may cause a build-up of torsional stress into the conductor. The need for larger diameter is crucial.

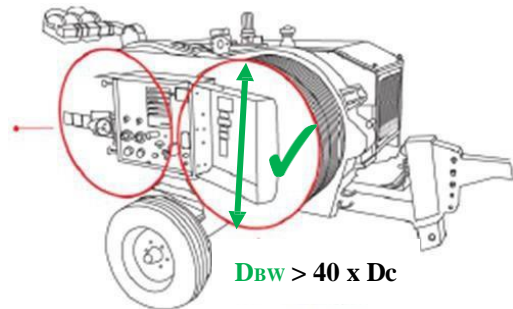

3.6. **Tensioner should be of rubber faced double bull wheel** type (or Tilted Multi Groove Tensioner) with sufficient number of grooves to keep the outer layer from slipping over the underlying layer 4 wraps). Groove surface shall be smooth and free from rough edges. (Single V-groove type bull wheel or Combination Bull wheel Tensioner/pay-off Trailer shall never be used).

3.7. The conductor end pulls from top of the drum and aligned straight with the groove of the tensioner capstan. ACFR conductors built right-hand lay ("Z") shall be fed through front tensioner wheel on left-most groove and exit from the top right-most grooves of the back-side-wheel, facing in the direction of the pull within < 5° deviation on the right half side.

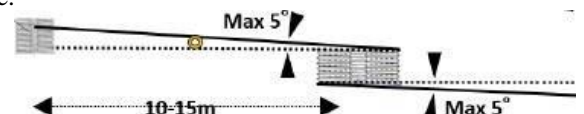

3.8. Tension Site Set-up

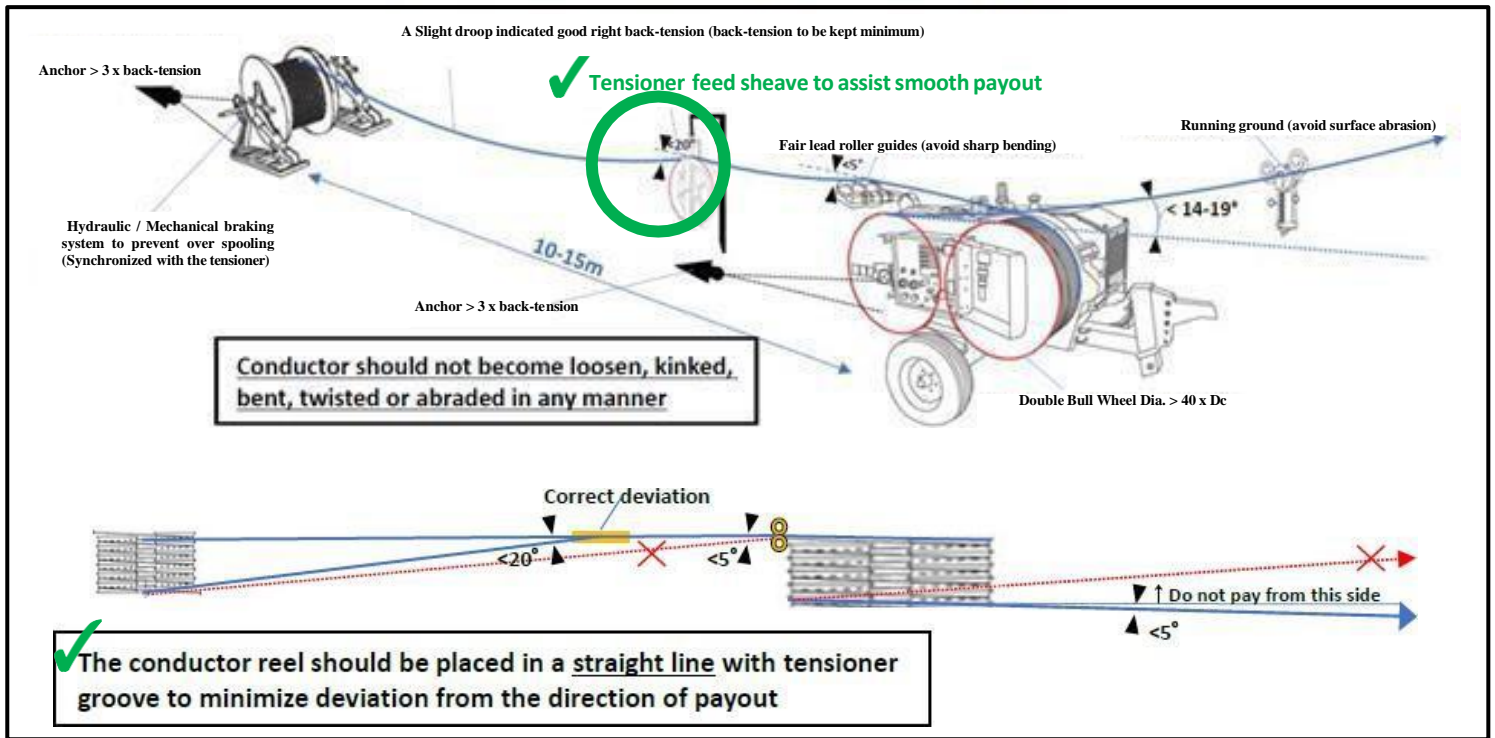

A) Bullwheel Diameter must be bigger than 40 x conductor Diameter.

B) Radius of the grooves (Rg) should be sized correctly.

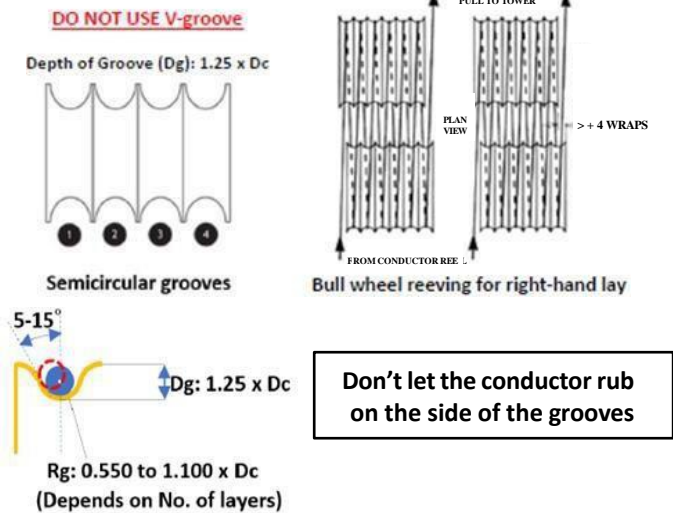

No. of layers of Aluminum wires	Bull wheel Diameter at Bottom of Groove: Db	Radius of Groove: Rg		Depth of Groove: Dg
		Minimum	Maximum	Minimum
1 or 2	40 x Dc	0.525 x Dc	1.100 x Dc	1.25 x Dc
3		0.525 x Dc	0.750 x Dc	1.25 x Dc
≥ 4		0.525 x Dc	0.625 x Dc	1.25 x Dc

C) Tensioner feed sheave must be used to correct deviation and facilitate smooth entering of the conductor into the tensioner in a manner that conductor is not being twisted or bent.

D) Problem of bird caging can be remedied by allowing enough distance between the conductor drum

and the tensioner to allow the strand looseness to distribute along the intervening length of conductor evenly and simultaneously maintaining enough back tension on the drum to stretch the core and inner strands to sufficiently tighten the outer strands.



E) The puller and the tensioner must be rated for pulling capacity and equipped with dynamometer (tension indicator), limiting devices. (The annexure D,F,H & I of IEEE524 may be referred for calculating the capacity) Positive braking system is required to maintain a constant tension to operate smoothly without causing any sudden jerking or bouncing of the conductor at all pulling speed and when the pulling is stopped. Recommended speed of payoff is 20-40m/min. Increase and decrease of pulling speed should be gradual. Swinging of the conductor caused by inconsistent pulling speed or unsynchronized operation should be avoided.

F) Assure that the conductor is not jumping or bouncing during payout. Synchronized breaking of the drum with the tensioner is desirable. Excessive braking can cause the top layer of conductor to “crush down” into the underlying wraps and damage or distort the outer strand.



- G) Drum/ Drumstand: The braking of the drum shall be kept as minimum level necessary to allow the tensioner to draw new conductor from the drum smoothly and evenly and also to prevent over-rotating (backlash or free-spooling) when the pulling stops. The braking force should not exceed 4.5kN. Pay-off brake tension shall be continuously monitored throughout the pull and lowered as the drum empties.

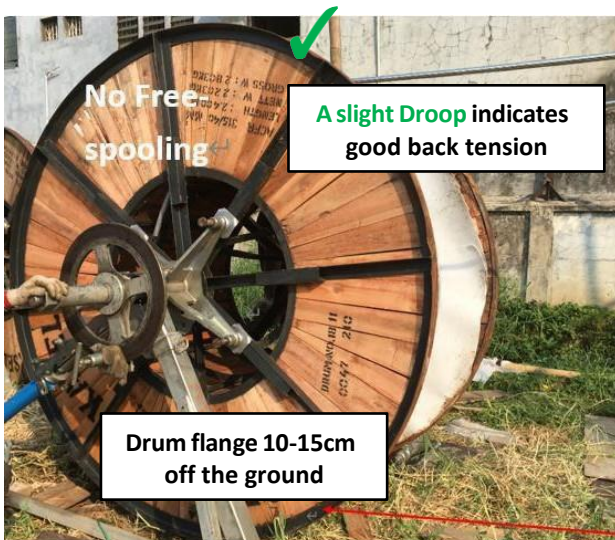

3.9. Semi-Tension Method (for smaller dia. conductor)

Semi-tension method is similar to tension stringing method except in this method the conductor is pulled directly off the pay-out drum. Very low clearance is maintained by applying minimum breaking force to the payoff drum. Breaking force shall be kept minimum level necessary as not only to prevent damaging the remaining conductor on the drum but also to prevent collapsing the drum itself. Drum stand must be securely anchored with $> 3 \times$ pulling tension. Breaking capacity of the drum must be checked to be sufficient for the planned pulling tension for maintaining required clearance; or Tension stringing method (with breaking by tensioner) or cradle method should be considered in case that pulling tension exceeds breaking capacity of the drum. Any bellies which may cause excessive bend must be avoided and min. **Bending radius must be respected at all times.**

3.10. Slack and Layout Method

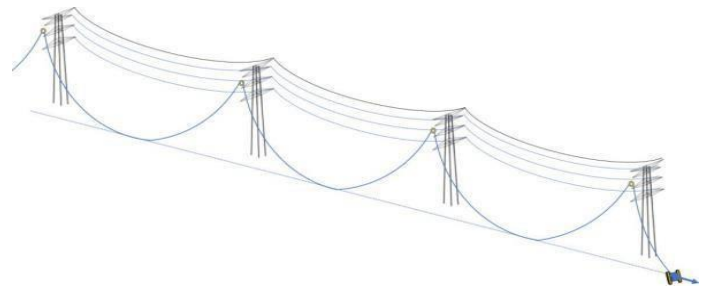

Slack and Layout method is applicable when maintenance of conductor surface condition is not critical (or matting to protect the conductor surface is provided) and where the terrain is easily accessible to a pulling vehicle. This method should not be used in urban locations where hazards exist from crossing traffic or energized circuits, nor is it practical in hilly terrain inaccessible to pulling vehicles. This method is not desirable for:

- Annealed aluminum conductor
- Urban locations
- Crossing traffic or energized circuits
- Hilly terrain

3.11. Manual Stringing

- A) **AVOID damaging the soft aluminum layers by dragging the conductor on the ground or over obstacles.** Conductor being paid out should be laid on matting on the ground to prevent scratching and damaging on the soft surface of annealed aluminum wires. It shall be assured that the ACSR conductor is always kept out of the dirt.



- B) **The conductor should not be dropped or pulled over obstacles or edges such as rocks, walls, fences etc.** All obstacles such as Rocks, Walls, Fences, Trees, Rivers, Roofs, Scaffoldings along the way shall be treated in a manner that will not cause excessive bend or dragging. It shall be assured that the conductor will contact only surfaces that are minimum sheave working diameter or greater. Rotation of the drum should be controlled with minimum breaking force to prevent over run, backlash or loop to avoid damaging the remaining conductor on the reel.



C) Avoid any bellies which may cause excessive bend during manual stringing. Particular care shall be taken when lifting up the conductor not to allow sharp bends of the conductor. Deformation of aluminum strand should be evaluated for the possibility of damage to the core.

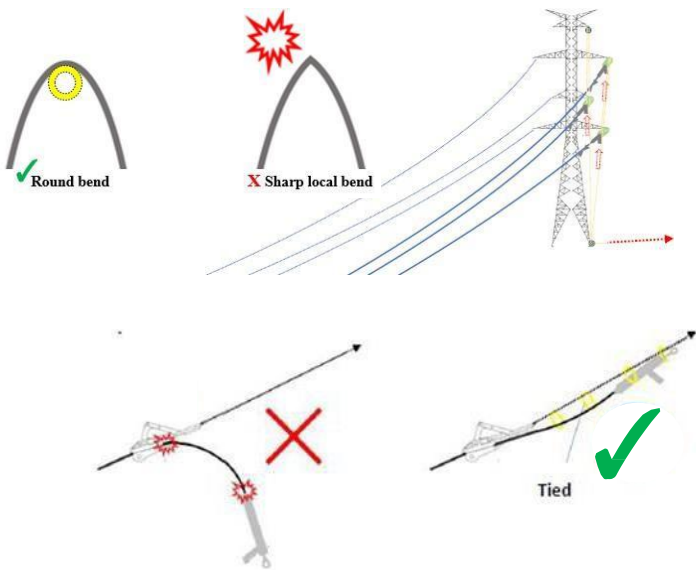

D) Avoid sharp bend when laying the conductor over structure. It is okay to drape slack the conductor across small roller but it would not be acceptable if the bend were local and the conductor were under tension. Conductor should not be pulled across obstacles.



Roller should be used when pulling the conductor over obstacles

4. INSTALLATION OF RUNNING SHEAVES

4.1. A minimum bottom groove diameter (D_s) of $20 \times$ conductor diameter (D_c) is generally recommended for typical pulls with level spans and partial turns (less than 60°). D_s must be $> 60 \times$ cfcc core diameter. **DO NOT USE smaller than recommended diameter sheaves which may cause build-up of torsional stress into the conductor and/or distortion of aluminum layers.**

4.2. All sheaves should be lined with a resilient liner such as neoprene or polyurethane and constructed of lightweight, high-strength materials. Plastic lining of urethane or neoprene with rigid frame are recommended. It is advisable to check that their inner surface is free of defects that could potentially scratch the conductor's aluminum strands. Bare aluminum sheaves are not acceptable for annealed aluminum conductor as it may damage the surface of the conductor. All sheaves must be checked for load rating and in good working condition without damage/worn and properly lubricated prior to use.

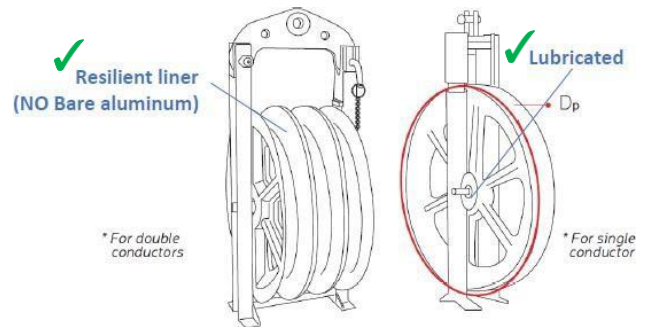

4.3. **Radius of Groove:** Use well-fitting groove to ensure efficiency of the stringing operation and to avoid uneven pressure applied to conductor as it passes through the sheave and build-up of torsional stress on the conductor. IEEE524 criteria should be applied for selection of sheaves.

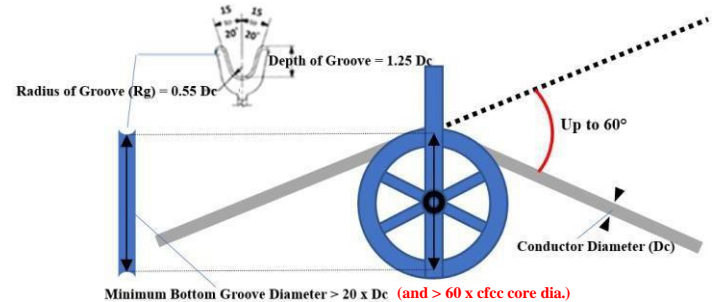

Number of layers of Aluminum wires	Radius of Groove (Rg)		Depth of Groove (Dg)
	Minimum	Maximum	Minimum
1 or 2	$0.55 \times D_c$	$1.100 \times D_c$	$1.25 \times D_c$
3	$0.55 \times D_c$	$0.750 \times D_c$	$1.25 \times D_c$
≥ 4	$0.55 \times D_c$	$0.625 \times D_c$	$1.25 \times D_c$

4.4. When pulling the conductor around angles greater than 60° , or when there is severe uplift or down pull forces, Tandem or oversized sheaves should be used to minimize breakover angles/keeping allowable bending radius.

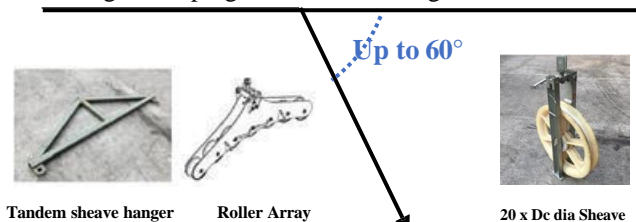

- 4.5. **Sheaves at angles should be RIGGED UP** to match the plan of the conductor path to allow the conductor to roll along in the center/ bottom of the groove to minimize torsional stress. If the conductor runs off the center, it will roll on sides and being twisted which would cause loosening/squeezing of the aluminum strands and/or damaging the core of the conductor.
- 4.6. It should be noted that conductor will tend to loosen or tighten its strand when traveling over sheaves, turning 50-55 degree per sheave. If the conductor runs off the center, it will roll on sides and being twisted which would cause loosening/squeezing of the strand and/or damaging the core of the conductor.

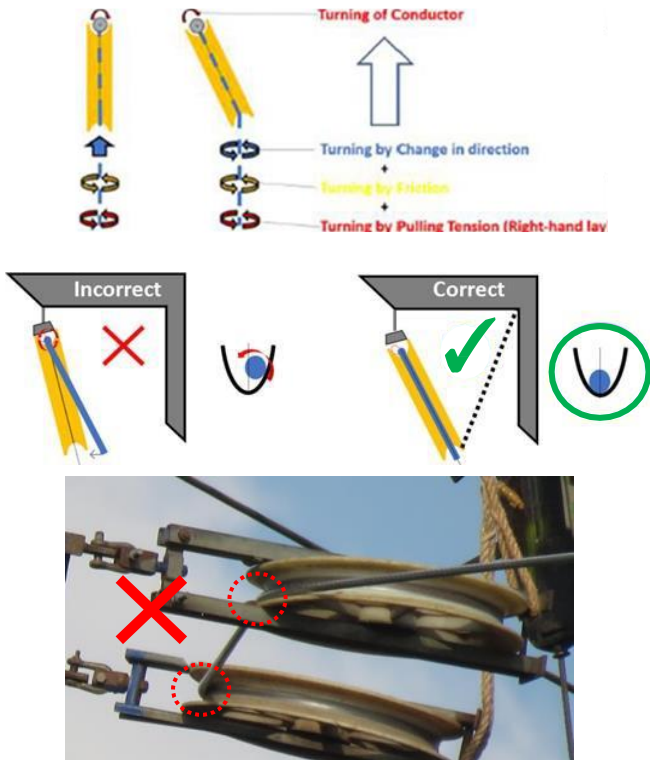

5. PULLING CONDUCTOR(S)

- 5.1. For back-to-back pulling, up to three drums may be joined by correctly sized wire mesh grips and swivels if the site condition do not allow proper access.
- 5.2. As a guideline, pulls should not be more than 20 spans and/or 3 drums to avoid excessive increase in pulling tension.
- 5.3. Use of Anti-twist wire and multiple swivels between old conductor and new conductor is recommended to avoid transferring the torsional stress from old conductor.
- 5.4. It is advisable to keep the pulling tension minimum necessary (50-70% sagging tension) to minimize the rotation of the new conductor.
- 5.5. Pulling wire (RTS>2.5 pulling tension) should be lighter than the conductor to avoid unnecessary increase of the pulling tension to maintain clearance. In case that old conductor is used as a pulling wire, it must be assured that the old conductor is free from damage.
- 5.6. When multiple reels are pulled to extend sections, splices are normally installed only after the conductor has been pulled into position. Splices must never be allowed to run

through sheaves, (unless specialized splices and procedures are certified to facilitate safe, reliable installation.)



- 5.7. Torsion releasing swivel(s) must be used between drums to avoid transferring torsional stress from the conductor in front and also to release torsional stress coming from the conductor itself during the pull.

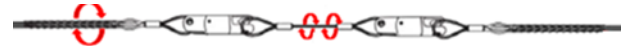

- 5.8. Use of swivel(s) is required between the old conductor and new conductor as well as between drums to avoid transferring the torsional stress from the conductor as well as releasing the torsional stress coming from unwinding force of tensioned new conductor itself as conductor(s) will rotate when the pulling tension on the aluminum strands is more than aluminum strands can take.

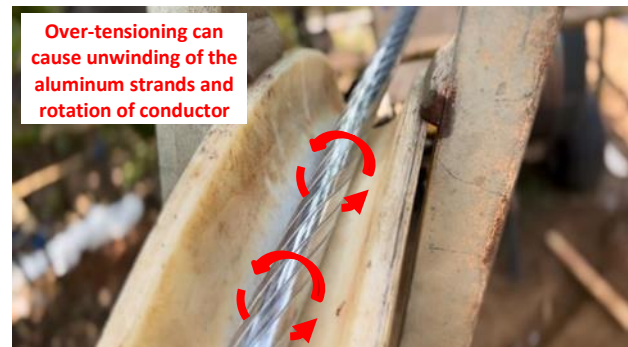

- 5.9. Maintaining minimum constant tension and releasing torsional stress is crucial for back-to-back pulling.
- 5.10. Excessive built-up of torsional stress into conductor can result in bird-caging or snaking. Excessive accumulation of torsional stress into the conductor will result in the opening of strand (birdcaging - loosening) or popping out of outer aluminum strand (snaking - squeezing). Installer must use proper torsion releasing techniques in case of long pull with higher pulling tension.

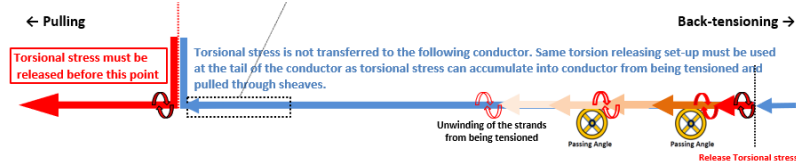

Twisted portion of aluminum layers should be evaluated for the extent of damage and repaired properly to restore conductivity and the strength of the core (refer to 9.3)

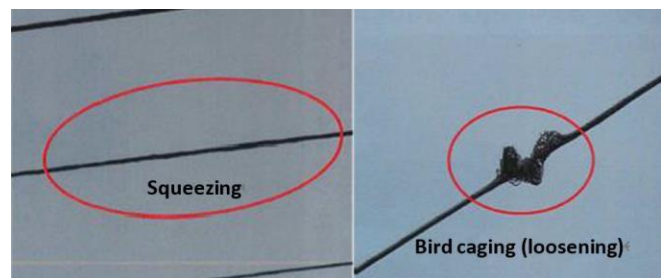

5.5. It should be noted that **twisting of conductor should not exceed the below limit** which is based on the Force-twisting test result of ACFR 200mm² till core failure. (Length: 1m, Dc: φ18.31mm, 2 layers + φ6.8mm cfcc core)

<u>Turning (outermost layer)</u>	<u>Core Failure</u>
Squeezing :	250°/1m
Loosening :	360°/1m

Example of conductor core failure as a result of excessive built-up of torsional stress into short length of the conductor caused by:

- ① Exceeding the back-to-back pulling limit (pulling section exceeds 20 spans) .
- ② Failure to use torsion releasing technique (swivel was not used between drums and the midspan joint splice was installed at tension site for connecting conductor drums.
- ③ Poorly maintained non-rotating running sheaves and the conductor not running center bottom of the groove caused more turning of the conductor.
- ⑤ Inconsistent pulling tension causing concentration of torsional stress into short length of conductor.
- ⑥ Failure to monitor conductor condition when passing through sheaves and ①-⑤ were not corrected during the pull.

5.6. **ACFR conductor may be pulled back-to-back up to 20 spans.** Each conductor ends must be joined by two wire mesh socks with core retainer. Jointing swivel is recommended be used between each drum for assuring safety. Midspan joint splices must be installed after the conductor is in place or pulled through the last relevant sheave. Midspan joint splices must never be pulled through sheaves unless specialized sheave arrangement and procedures are certified to facilitate reliable installation.

5.7. **Double check equipment condition and load ratings of swivels and wire mesh grip** since back-to-back pulling requires higher pulling tension (must never exceed 70 % of sagging tension). A Correctly Sized woven wire mesh grip to fit over the conductor with adequate length should be used. (A+L 1.70m is recommended). Mismatch in dimension may result in conductor slip or damage to the conductor. Grip must be double-banded on the ends to prevent slipping. The portion of the conductor that are covered with wire mesh shall be cut off after removal of wire mesh.

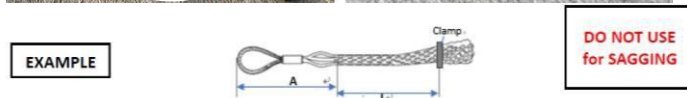

Conductor Dia. (mm)	Dimension A/L (mm)	Max. Working Tension (kgf)	Breaking Load (kgf)
45.2 - 53.7	330/1,500	7,000	16,000
38.0 - 45.2	300/1,300	5,000	11,000
32.0 - 38.0	300/1,200	3,600	8,700
26.9 - 32.0	250/1,000	3,000	7,200
22.6 - 26.9	250/1,000	2,500	5,800
19.0 - 22.6	240/1,000	1,000	4,300
16.0 - 19.0	230/900	1,600	3,600
13.4 - 16.0	210/800	1,400	3,600
11.3 - 13.4	200/700	1,100	2,800

5.8. When pulling through long sections and/or with higher pulling tension, it is recommended to restrict the sliding movement of the core with binding wire to keep the CFCC core from slipping inside (soft) aluminum layer, so the core can be accessible for splicing. Locking with two binding wires usually works well.



CFCC core can slip inside aluminum layer by tension stringing

5.9. For pulling twin/multiple bundles, use of running board is recommended to keep the conductors from toppling over. In case of pulling longer than 4km, these values may be increased by 5kg. in case that pulling tension is higher than usual, it is recommended to have torsion releasing swivels behind the counterweight as conductor may rotate from being over-tensioned.

Reference:		
	Pulling Tension kgf (kN)	Weight of Running board(kg)
	1,000 (9.8)	15kg
	2,000(19.6)	20kg
	3,000(29.4)	30kg
	4,000(39.2)	40kg

5.10. **In general, max. pulling tension is about 50 to 70% of sag tensions. Pulling Tension will vary depending on environmental condition of intended route and the stringing efficiency. General pulling tension (single) for conventional sizes are:**

- ACFR410mm²: 1,600-2,600kgf
- ACFR610mm²: 1,800-3,000kgf
- ACFR810mm²: 2,300-3,200kgf

5.11. Back-tension is approximately 75% of pulling tension. Increase/decrease of pulling speed should be gradual.

5.12. Caution should be used to keep the minimum necessary pulling tension **as over-tensioning may cause build-up of torsional stress into the conductor** as aluminum strands tend to unwind themselves if the pulling tension is more than the aluminum strands can take.

5.13. In case that pulling tension exceeds more than usual, pulling section may be broken down into separate pull.

5.14. Sagging tension shall never be exceeded during stringing or sag behavior will be affected.

5.15. Pulling through angles and elevation changes will increase the pulling force and tighter sag values with clearance restriction will also increase the pulling force. Pulling tension on conductor will increase 2% when traveling through one sheave and large elevation changes also increase the pulling tension by the net weight of the conductor(s) in the vertical change.

5.16. If the conductor must be left in the sheaves for an extended period of time (more than 72 hours), it should be left at a tension less than 50% of sagging tension (close to pulling tension). Loose tension poses big swing risk in strong wind which causes conductors to clash each other or moving back and forth on sheaves. Conductor on sheaves may be temporarily fixed to keep it from moving back and forth on sheaves which can cause nicking the outer aluminum strands or damaging the core of conductor (this is especially important for smaller diameter conductor with lighter weight).

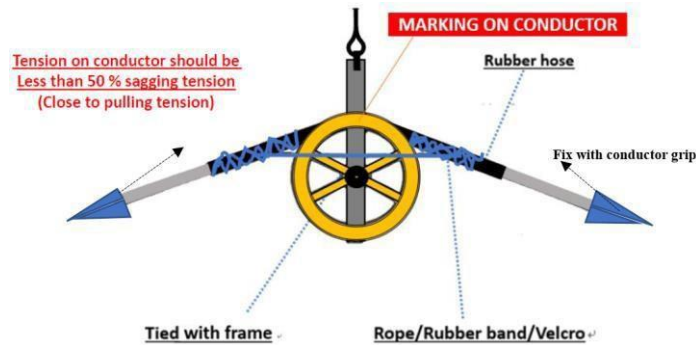

6. SAGGING

6.1. **Conductor Grip:** It shall be assured that the grip does not over-tension or deform individual wires and capable of holding the conductor to the highest tension that is anticipated during the sagging operation. (Any grips, which transmit excessive crushing force to the core, should not be used.)

6.2. **Klein “Chicago-type” grips are recommended.** Grips must be properly sized for the conductor diameter. Length of jaw is recommended to be 170mm+ for conductor diameter 22mm and smaller and 270mm+ for bigger conductors. In case that conductor uses 0-temper aluminum, Klein Chicago grip tool guide (for ACSS which also has 0-temper aluminum) should be followed.



Klein “Chicago-type” Grip

6.3. In case of gripping for higher tension (more than 10% RTS) for long span or when extra redundancy is needed, double/tandem gripping is recommended to avoid slippage.

6.4. **Conductor uses 0-temper aluminum with diameter below 24 mm is recommended to be double gripped when the tension is more than 10% RTS of the conductor.**

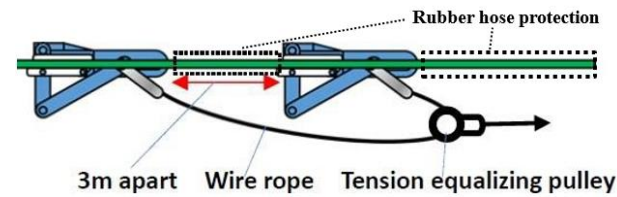

6.5. To keep the conductor surface from scratching with wires, it is recommended to protect the conductor surface with **wraps of rubber hose**. This is particularly important for conductor with soft 0-temper aluminum.



6.6. For Pocketbook-type grips, the nuts used to close the grip must be free-running. The bolts must be properly tightened with full torque recommended by the manufacturer



Pocketbook type Grip

6.7. It is recommended to take a section of conductor to be installed and, test the holding strength of the grips using chain hoist and dynamometer to verify grip holding strength. The Grip should not slip when subjected to a minimum tension of 150% of the working tension during installation.



6.8. Flexible ACFR conductor can tolerate drape slack from conductor grip however, this would be unacceptable if the conductor is tensioned or if the crew were pulling the conductor tail. In case that installation of ACFR Dead-end clamp takes place on the ground, caution shall be used to avoid sharp local bending at the grips.

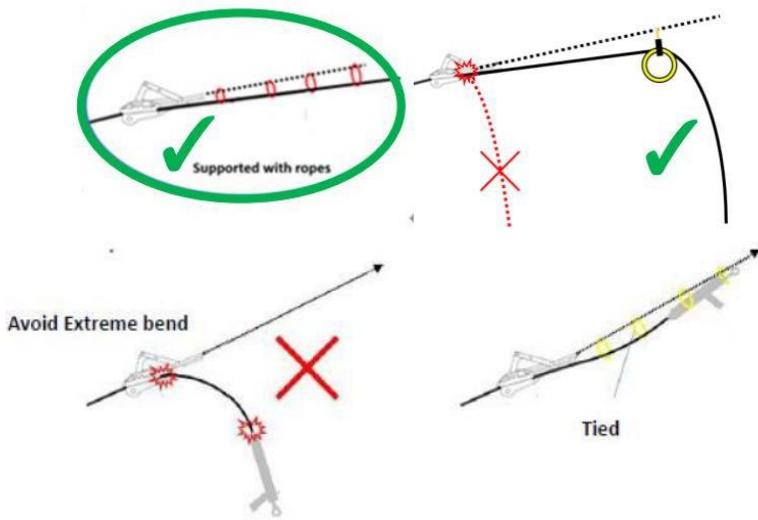

6.9. Always avoid sharp local bend at the conductor grip. Excessive bending can cause opening of aluminum strands. In case of that conductor damage includes evidence of over-bending, kinking, or crushing, the suspect section should be evaluated for the extent of damage.



6.10. Conductor end must be ALWAYS supported during splicing to avoid sharp bending of conductor.



Installation of Deadend clamp on the tower

6.11 Placing a sheave a full size sheave (20 x Dc) next to the conductor grip (3meters away and slightly below conductor grip) can avoid excessive local bending during installation of dead-end on the ground. It is okay to drape slack the conductor across small roller but it would not be acceptable if the conductor were bent sharply under tension. **It must be assured that bending of the counductor is round in case of pulling down the conductor to the ground.**



Installation of deadend clamp on the ground

7. SPLICING AND ACCESORIES

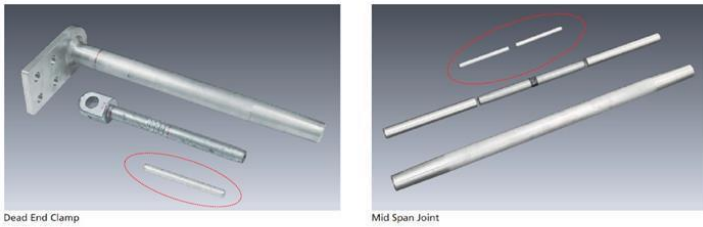

Buffer can be either Inserted aluminum sleeve or Bottom layer of outer aluminum layer, depending on design.

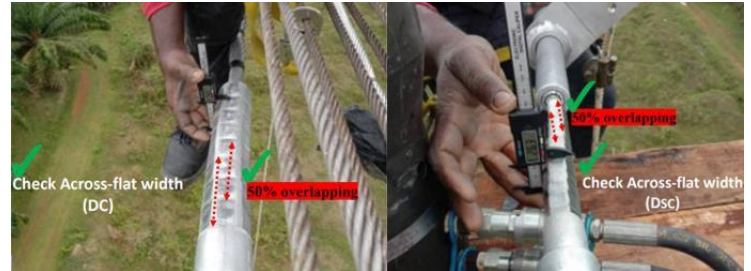
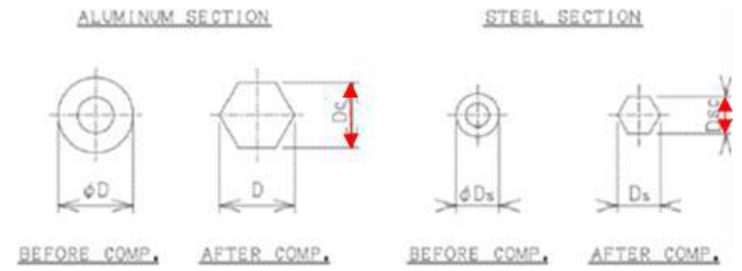

Upper/Bottom die must mate completely to avoid curvature



Aluminum buffer insert OR Bottom (soft) aluminum layer is used to grip the cfcc core. Installer must Check manufacturer's recommendation

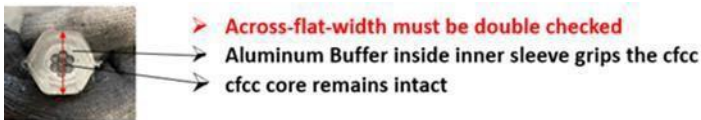

- 7.1. ACFR uses **compression type splicing** that is similar to ACSR. Notable difference is that ACFR uses soft aluminum buffer components which grips the CFCC core inside inner steel sleeve (either inserted type buffer or bottom layer of outer aluminum layer is used to grip the core).
- 7.2. Installer must check installation procedure as per manufacturer's recommendation.
- 7.3. Conventional compressor and dies used for ACSR can be used for installation. **Across-flat width after compression should be checked for both inner and aluminum sleeve in accordance with manufacturer's recommendation.**



Each press to be overlapped at least 50 % with the previously pressed portion to avoid curvature. Care must be taken to avoid curvature of the inner sleeve. excessive curvature of the inner sleeve can cause difficulties when installing the aluminum sleeve.

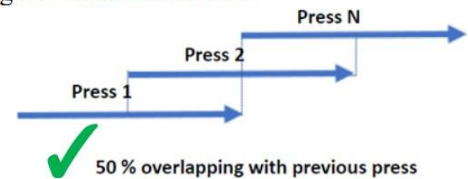

- 7.4. Direction of compression must be checked as per manufacturer's recommendation. **Reverse compression (from tower to conductor) should ONLY be used when clearly specified.** Pressure must be checked as per requirement and it must be assured that die surfaces mate completely for each press. Insufficient compression can result in slippage/failure. The slight loosening of aluminum wires (which is unavoidable when compression the fitting) will move into the span later (and is not a problem) after tensioning and energizing. Note that there is added space for the aluminum to move towards the steel eye when reverse compressing in this case. Jumper socket for ACFR conductor is compression type similar to ACSR and CFCC gripping component is not required.

- 7.5. **Exposed portion of the core should be kept from sharp-bending and/or twisting** during installation of Dead-end and Mid span joint.



7.6. Cutting the conductor: **stripping of aluminum layer shall be done by cable trimmer. The bottom layer shall be stripped by repetitive bending only.** The final cutting of the core must be done by fine-tooth hacksaw or disk cutter to produce a clean cut. The core shall never be nicked or scratched during the stripping. Hydraulic cutter can be used for rough cutting but should not be used for cutting the core. Rough edges of the core may be removed by metal file.

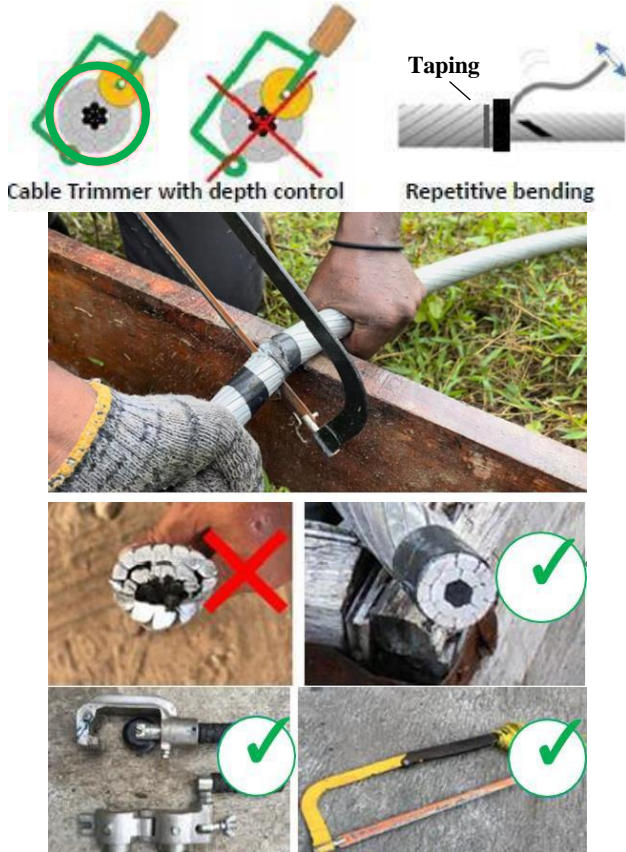

7.7. Midspan Joint

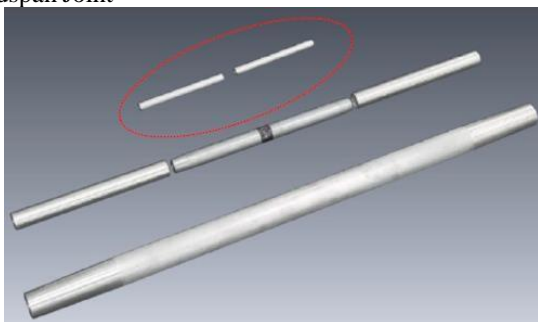

Length of midspan joint for ACFR is longer than ACSR. midspan joint are normally installed only after conductor has been pulled into position.



7.8. Full sized hold-down/let-up block should be used to avoid excessive bending during holding down and/or letting up the conductor before and/or after the installation of midspan joint. **DO NOT USE NARROW SLING OR ROPE.**

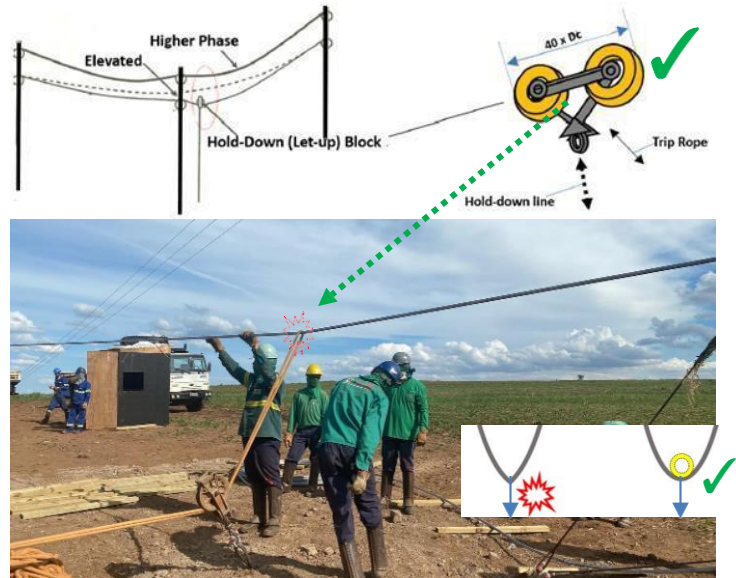

Use Hold-down \ Let-up block to avoid sharp bending

7.9. Typical ACFR suspension clamp is armor-suspension clamp. The main body is of cast iron or aluminum alloy and the conductor is wrapped with heat-resistant rubber, and the holding metal fittings are tightened with bolts while the armor rod is wound. **Appropriate wire lifting hook must be used when transferring the wire from the running sheave to the suspension clamp to prevent local bending.**

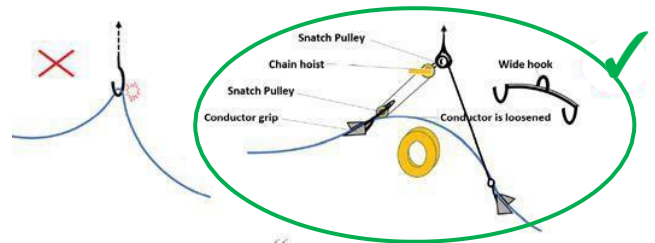

Triangle frame hoist for lifting conductor for suspension clamp



Installation of Armor rod and suspension clamp

7.10. Aerial vibration on ACFR conductor can be mitigated with installation of vibration damper just like any other conductor. Dampers can be stock-bridge or dog-bone type or spacer damper type. Installation procedure as well as required tools such as bolt fastener must be checked as per manufacturer's recommendation. Damper and the use of the armor rod must be approved for 0-temper aluminum. Damper quantity and spacing shall be as per manufacturer's damper placement chart. Armor rod must be properly installed to protect the conductor strand from fatigue breakage.

7.11. In case that armor rod is used for the vibration damper, it must be assured that there is sufficient spacing between the edge of armor rod and the Deadend/Suspension clamp ($\pm 800\text{mm}$ for example, installers should use manufacturers recommendation) as to allow the aluminum strands to move to avoid fatigue breakage of aluminum strand caused by aeolian vibration or galloping of the conductor.

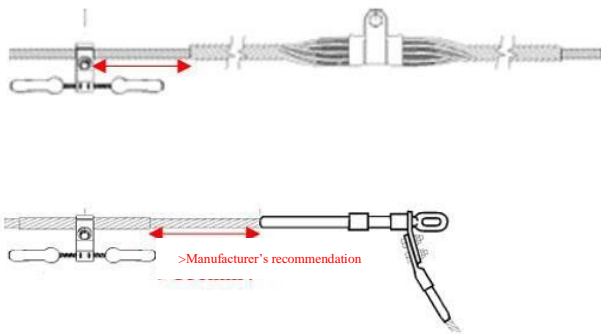

8. Damage Consideration

8.1. **Distortion of Aluminum.** In case that **opening of aluminum strand**, birdcage, squeezing, or kink is seen, it should be evaluated for the possibility of damage to the core. Damage to the composite core caused by excessive bending and twisting during installation can often be identified by deformation in the aluminum strands. CFCC core is flexible and can take bending to some extent and less likely to be damaged without aluminum deformation except in the case that the conductor was strung with tension through undersized sheaves. If the evidence of over-bending, kinking, or crushing, the suspect section should be repaired or replaced with new conductor.



Strand opening due to sharp "local" overbending

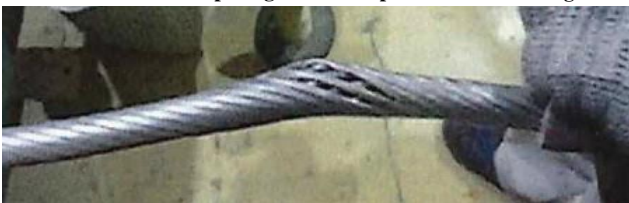

(single hook hoisting with tension)

Strand distortion due to "concentrated" overtwisting
(270° rotation squeezing of 1 m specimen)

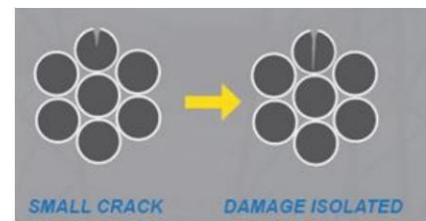

- 8.2. The stranded design of the CFCC core makes it structurally redundant and gives practical handling characteristic and more durability to the conductor. The unfortunate event of snapping of conductor due to core failure is restricted as the damage (if any) can be restricted without compromising the strength of the whole core.
- 8.3. Abrasion Damage can be identified by observing black deposits on the conductor strand which is caused by relative movement between conductor hardware and the conductor. Ensure that the cause of the abrasion is identified and corrected or it can result in failure of the conductor strands.
- 8.4. Assure that installed **line hardware and accessories** are not missing split pins, bolts or nuts and securely fastened as per manufacture's recommendation. Rusty/corroded hardware must be replaced.

9. REPAIR

- 9.1. Repairing of conductor surface shall be done only in case of minor damage, scuff marks, etc., keeping in mind both electrical and mechanical safety requirements.
- 9.2. Conductor distortion and minor birdcage can often be repaired by hand reshaping with a small block of wood and tapping the loosen strands out into the open span.
- 9.3. Repair sleeves may be used when the damage is limited to the outer layer only and does not affect more than one sixth of the strands of the outer most layer. No repair sleeve shall be fitted within 30 meters of tension or suspension hardware fittings. (More than one repair sleeve per conductor should normally not be permitted in any one span.)

Repair Method	Extent of Damage				
	Number (or %) of damaged aluminum strands in the outer layer			Damage on inner aluminum layer	Damage on CFCC Core
	1 (or < 10%)	2 (or $\leq 10\%$)	More than 2 (or > 10%)		
Armor Rod	✓				
Repair Sleeve	✓	✓			
Mid Span Joint			✓	✓	
Replace with new conductor					✓

10. REFERANCES:

- 10.1. *IEEE 524 Guide for the installation of Overhead Transmission line Conductors* (2016)
- 10.2. *IEEE 516 Guide for Maintenance Methods on Energized Power Lines* (2003)
- 10.3. *Power line safety 1926.1409 Occupational Safety and Health Administration* (2010)
- 10.4. *TLT-5 Kasen-kouji Gijyutu Kaisetsu, Denki-Shoin* (2010)
- 10.5. *Japan TX Line Construction Committee (Soudensen-Kensetsu-Gijyutsu-Kenkyukai) No.22 (Dec.1994)*

11. PUNCH OUT LIST (✓)

11.1. PREPARATION

- A) The intended conductor route is thoroughly inspected for specific locations of bend and any obstacles and crossings (such as trees, billboards, existing lines, highway, etc.) are treated in such a way that conductor will not be over-bent, twisted, dragged or pulled across over obstacles?
- B) Suitable crossing support structures/scaffoldings are used when obstacles like line, road, rail etc. are to be crossed?
- C) Have the entire stringing crew been familiarized with the handling parameters and work procedures?
- D) Drum Storage and Transportation is carried out in a manner not to damage the conductor?
- E) A sample of each type of ACFR conductor's midspan joints / dead-end assemblies have been tested for tensile strength in accordance with customer requirements and approved?
- F) Approved Hardware and Fittings (Dead-end clamp, Jumper terminal Suspension clamp, Spacer, Damper, Armor rod, Aircraft warning sphere, bird-diverter etc.) have been delivered with the manufacture's recommended Installation procedure?
- G) The planned pulling tension is < 10% Conductor RTS? If not, it shall be assured that pulling tension does not exceed 50-70% of sagging tension.

11.2. RUNNING SHEAVES

- A) All the pulling angles at tension towers have been checked for more/less than 60° for sheave selection?
- B) Min. Sheave Dia. > 20 x Dc are selected for pulling angles < 60°?
- C) Oversized or Multiple Roller Sheaves are selected for locations with pulling angle > 60°?
- D) All the Running Sheaves are properly lubricated and lining on the grooves are in good condition to ensure smooth traveling of the conductor?
- E) Are the sheaves at the suspension towers installed in offsetting position to avoid unnecessary contact between conductors?
- F) Oversized Hold-Down/let-up sheave are selected for installation of midspan joint not to allow overbending?
- G) All the running sheaves at angles are rigged up to align with conductor pass so that conductor runs on the center of the groove?
- H) Are all the installed sheaves diameter equal to or larger than required?
- I) Necessary Support/Back stay for Tower Cross arm are installed?

11.3. TENSION SITE

- A) The break over angle at the first sheave is reduced <30 °and/or an oversized sheave is used?
- B) The tension site is located in a position allowing the conductor to be pulled straight to the first structure?
- C) Drum – Tensioner is positioned in a manner that the conductor will not be over-bend or twist?
- D) The Tensioner Feed Sheave has been installed between drum and tensioner?
- E) The conductor is fed through the center of the tensioner feed guide roller without bending?
- F) Braking on the drum is kept steady and minimum necessary? (Slight droop between drum and tensioner feed sheave indicates correct back tension).
- G) The conductor drum is not free spooling?
- H) The conductor is ready for consistent and smooth payout without bouncing or jumping?
- I) The Grounding Block is installed?
- J) Anchorage for the Drum stand and the Tensioner (> 2.5 x working back tension) are installed?
- K) The payoff conductor is not being twisted on the side of the groove?
- L) The rewinding of the conductor is carried out in a way that each wrap of the conductor does not cross over?
- M) A swivel is installed between the old conductor and new conductor?
- N) ACFR Midspan splices are NOT to be INSTALLED at tension site? as splices are normally installed after the conductor has been pulled into position (unless specialized splices and procedures are certified to facilitate safe, reliable installation.).
- O) Are sizes and rating of the wiremesh grip correct? Up to three drums joined by proper wire mesh grip may be pulled back-to-back if the site conditions don't allow proper access. As a guideline, pulls should not be more than 20 spans.

11.4. STRINGING

- A) Is the planned pulling section < 3 drum and/or 20 spans? Or specialized arrangement/procedures has been certified to facilitate reliable installation?
- B) Radio Communication is maintained and; Designated watchmen are positioned at angles/obstacles to monitor and report traveling of conductor?
- C) Support structures and rollers are installed to prevent the conductors to come into contact with the obstacle and without dragging or sharp bending.
- D) Support structure/scaffolding is constructed in such a way as not to cause sharp bends of the conductor?

- E) All the tension bearing equipment such as pulling wire, swivel/fixed joint, connecting wire, mesh grip etc.) is rated for >2.5 x stringing tension and selected in a manner to minimize torsional stress?
- F) Is pulling wire/anti-twist wire in good condition without kink/damaged strand?
- G) Connecting wire between conductor is in same laying direction as the conductor?
- H) Correct counterweight is installed and the conductor is not rotating inside?
- I) The wire mesh is securely joining to the conductor with core retainer?
- J) Tensioner operation is preceding to maintain constant back tension?
- K) The conductor is not over twisted during the pull?
- L) **Reporting Overbent / Twisted section of ACFR?**
- M) Avoiding pulling the conductor above sag height?

11.5. MIDSPAN JOINT SPLICING

- A) When installing midspan splicing on the ground, Full size Hold-down / Let-up block are used to avoid sharp bending of the conductor? rope should never be used to pull down conductor as to avoid sharp bending of the conductor.
- B) Step-by-step installation procedure has been confirmed and understood as per hardware manufacture's recommendation? (check compression/non-compression are and direction of press)

11.6. SAGGING

- A) The Conductor Grip is tested not to cause aluminum distortion or slippage when tensioned with 150% working tension prior to the use?
- B) Conductor is to be pulled up to scheduled sag within 24 hours of installation and clipped in within 72 hours of stringing?
- C) Conductor uses 0-temper aluminum with diameter below 24 mm is double-gripped?
- D) Double-Gripping technique is used for long spans (500m+) and/or higher sagging tension spans?
- E) The workers participate in sagging and clamping activity are fully familiarized with handling parameter? (Avoid local sharp bend at grips and always support conductor end with ropes)
- F) Is the dynamometer calibrated?
- G) The scheduled sagging tension is within allowable loading limit?
- H) Bundled conductors are all sagged at the same time to ensure matched sag?

- I) The sag is double-checked with sag scope and meeting clearance requirement?
- J) The conductor is fixed on the sheave not to move in case it will be left on sheaves over extended time?

11.7. CLAMPING (Tension)

- A) The outer aluminum layer is removed by Cable trimmer and repetitive bending to keep the CFCC intact?
- B) The Conductor End is supported not to allow sharp bend?
- C) The CFCC core is cut by fine tooth hacksaw to produce a clean cut?
- D) Direction of press (conductor ←→ tower) is confirmed as per manufactures recommendation?
- E) The exposed CFCC portion is kept straight and undamaged (no bend or twist) during splicing activities?
- F) The filler compound is fully injected without leaving air voids/gap inside the sleeves?
- G) Across-flat-width for dead-end inner/outer sleeve after compression is double checked with compression gauge?
- H) Jumper drop is as per drawing to meet the minimum clearance requirements?
- I) The bolts of jumper connection are properly fastened?

11.8. CLAMPING (Suspension)

- A) Lifting of the conductor to install the suspension clamp is done in a manner not allowing sharp bending?
- B) The armor rods are installed to match the center of plumb mark?
- C) The suspension insulators are hanged vertically?

11.9. VIBRATION DAMPER & SPACER

- A) Are Positioning, Spacing and quantity of damper/spacer as per manufacture's recommendation / placement chart? (Check long spans where extra damper is required)
- B) Vibration Dampers are hanging vertically and bolts are securely fastened as per the manufacturer's recommendation?
- C) Is there more than 800mm spacing between the edge of the armor rod and the deendend clamp?

-End of Section-