

MIGHTY NET

Rockfall prevention system

Conduces to natural landscape restoration
Slope stabilization
Fast growing greenery

TOKYO ROPE MFG. CO., LTD.

TOKYO ROPE MFG. CO., LTD.

NIHONBASHI FRONT BLDG. 6-2 NIHONBASHI 3-CHOME CHUO-KU TOKYO 103-8306 JAPAN
Tel.: + 81 3 6366 7788, Fax: +81 3 3278 6870

The Representative office of Tokyo Rope MFG. CO.,LTD. in Moscow

22, Bolshaya Yakimanka str., Moscow, 119180, Russia
Tel.: + 7 495 645 04 03, Fax: +7 495 645 04 09

The Representative office of Tokyo Rope MFG. CO.,LTD. in Kazakhstan

Office No. VP-62,7th floor,Business center "Na Vodno-Zelyonom Bulvare",
BLDG No. 12/1, D. Kunayev Street,Astana city, 010000, Republic of Kazakhstan
Tel.: + 7 7172 500 759, Fax:+ 7 7172 500 780

INTERNATIONAL INVESTORS Co. Ltd

Official Agent of Tokyo Rope MFG., CO. LTD in Kingdom of Saudi Arabia
Office 7 Dinaar Commercial Center, King Abdulaziz Road
PO Box 104451, Jeddah 21331, Saudi Arabia
Tel.: +966 12 236 5511, Fax:+ +966 12 236 5522

<http://www.tokyorope.co.jp/english>

Mighty Net prevents rockfalls, and efficiently conduces to natural landscape restoration.

Mighty Net advantages

Stabilization of loose rock and random rocks lying on the slope surface

Thick netting bears against the slope, preventing loose rock from creeping, and efficiently provides slope stabilization.

Ease of maintenance

Mighty Net firmly keeps rocks on a slope so that periodical removal of rocks rolled off to the toe of slope is not required.

Efficient greenery

Thick netting firmly covers the slope, decreasing soft soil erosion and conduces to the fast grow of plants, as soft soil and humus gathers in net meshes holding the roots and seeds of plants.

Optimal method for different kinds of slopes

Mighty Net creates no difficulties for hydroseeding and can be used as reinforcement for concrete and mortar.

Wide range of applications

Thanks to the ease of assembling, Mighty Net can be used for any type of the ground.



In the areas with frequent wind-caused rockfalls the application of the systems similar to Mighty Net, can lead to gathering of rocks at the toe of a slope. As a result, a net under the load of rocks lowers and can block the traffic becoming an obstacle for transport. Because of extensive loads, rocks must be removed out of the net. That is why the use of Might Net system is an optimal solution for the slopes of loose rocks.

Examples of completed projects using Mighty Net

Mighty Net can be installed on any type of terrain and is widely used as a system that prevents rockfalls. Furthermore, Mighty Net does not prevent fast growing of plants and conduces to efficient greenery.

In the background of the photo below is - the view of the slope after 1 year of Mighty Net installation. Stabilized slope conduces to the fast growing of plants and improves the scenery. In the foreground of the photo below is - the view of the slope soon after installation.

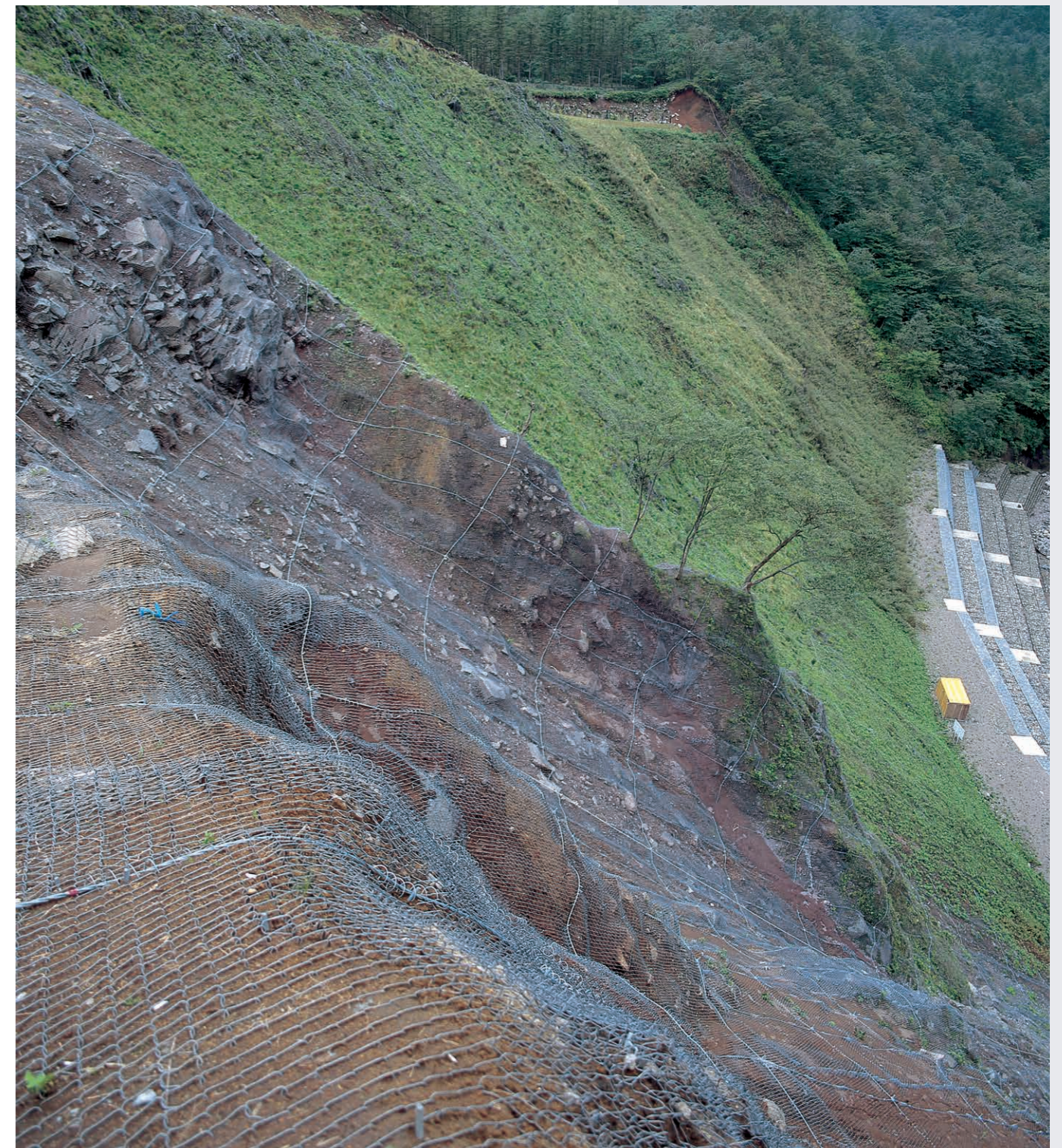

Examples of completed projects using Mighty Net



In course of time plants hide Mighty Net, fully restoring a natural landscape.



Examples of completed projects using Mighty Net



Examples of completed projects using Mighty Net



Examples of completed projects using Mighty Net

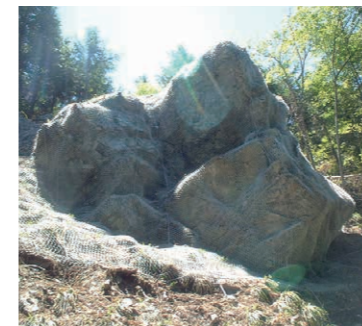

Mighty Net basic elements, high-strength thick net and flexible wire rope, follow the terrain features and stabilize slopes with uneven surfaces.

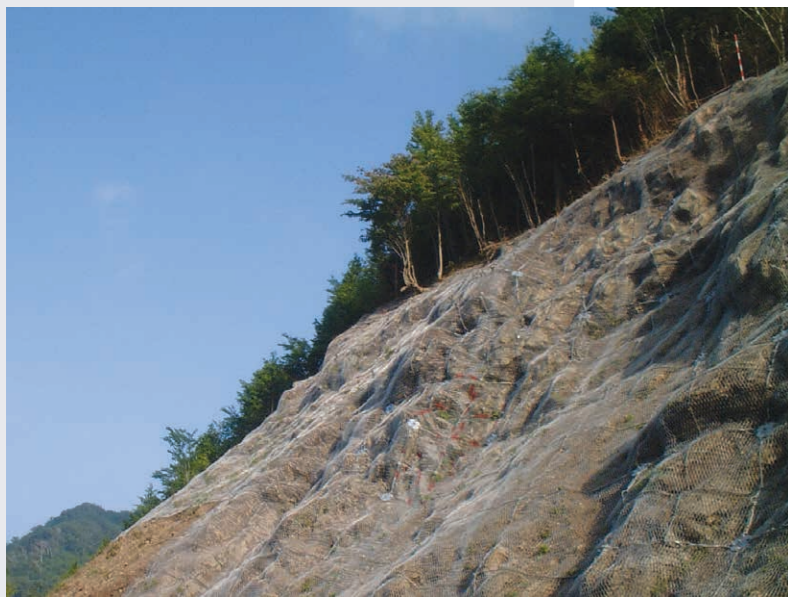

Mighty Net types

Unit of measure: mm

| Type | Wire rope | | | Thick netting | Anchor | | Sub-anchor | |
|------------------|-----------------------|-----------------------|-------------------------|----------------------|--|---|---|---|
| | Construction Diameter | Vertical interval (b) | Horizontal interval (h) | | Rock | Soil | Rock | Soil |
| 2 x 2 – 30 x 3.2 | 3 x 7 ϕ 12 | 2 (m) | 2 (m) | ϕ 3.2 x 42 x 30 | Cement anchor A, B D22(M20) x 1000 | Pipe anchor A, B ϕ 114.3 x 4.5 -1630 | Pin anchor ϕ 9 x 200 ϕ 13 x 300 | Pin anchor ϕ 13 x 500 Twisted anchors 6 x 500 |
| 2 x 2 – 50 x 3.2 | | | | ϕ 3.2 x 46 x 50 | | | | |

Notice 1: A type anchors are set at the net boundary

B type anchors are set inside the net

Notice 2: Sub-anchors of other sizes can be used depending on installation conditions.

Construction components

Unit of measurement: mm

| Type | Ropegrip | Wire coil | Cross-shaped grip | Cross-shaped anchor grip | Cross clip |
|------------------|---------------------------------------|-----------------------|-------------------|--------------------------|---------------|
| 2 x 2 – 30 x 3.2 | For ϕ 12 - 800 (Cement anchor A) | ϕ 3.2 x 50 x 300 | 50 x 95 | 50 x 95 | 4.5 x 42 x 42 |
| 2 x 2 – 50 x 3.2 | For ϕ 12 - 975 (Pipe anchor A) | ϕ 3.2 x 70 x 300 | | | |

Anchor installation

| Type | Settings procedure | Equipment and tools | Notes |
|------------------------------------|---|---------------------------------|--|
| Cement anchor A, B for rocks | Plunge a cement capsule into water for 5 minutes, until air bubbles stop escaping. Place the cement capsule in a 900 mm hole, made by 40-44 diameter drill. Place a twisted anchor into the hole. | Compressor Bit Rock-drill | Cement capsule (standard type) - ϕ 36 x 600 - 2 pieces (per 1 anchor) - at least 24 hours till full hardening of the construction |
| Pipe anchor A, B for soil | With the help of puncher place a pipe anchor into a 1.5 meter hole. | Compressor Puncher | |

Mighty Net strength

- Standard thickness of thick netting for an additional soil or mortar is 30 mm.

- Net thickness can be chosen depending on the thickness of additional soil or mortar.

- In case of difficulties, caused during the installation works, you can consult Tokyo Rope experts.

| Type | Load of falling rocks | | Slope ratio (1:X) | | | | | | | |
|--------------------------------------|-----------------------|-----|-------------------|-----|-----|-----|-----|-----|-----|-----|
| | kN/m ² | kN* | 1.0 | 0.9 | 0.8 | 0.7 | 0.6 | 0.5 | 0.4 | 0.3 |
| 2 x 2 – 30 x 3.2 2 x 2 – 50 x 3.2 | 12.50 | 50 | | | | | | | | |
| | 11.25 | 45 | | | | | | | | |
| | 10.00 | 40 | | | | | | | | |
| | 8.75 | 35 | | | | | | | | |
| | 7.50 | 30 | | | | | | | | |
| | 6.25 | 25 | | | | | | | | |
| | 5.00 | 20 | | | | | | | | |

*Load, applied to a mesh area, generated by the wire ropes (b-h)

In case of a rock rot at the area with steep slopes Mighty Net will firmly cover the slope and prevent rockfalls.



Cement anchor



The main component of a system that prevents rockfalls is an anchor. The cement capsule, used for its installation, is manufactured under strict quality control. Thereby cement anchor will be securely attached.

Installation procedure

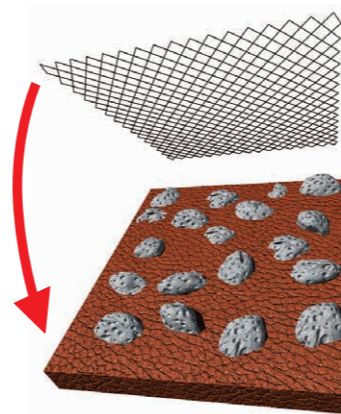

Stage 1

Thick netting is installed in the upper part of the slope and then attached by pin anchors until firm adherence is achieved.

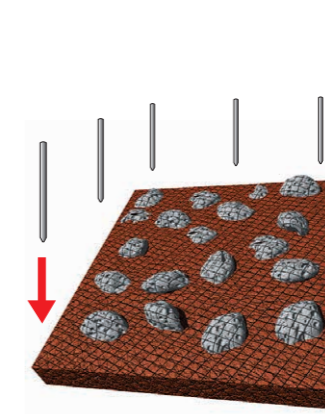

Stage 2

Locating the place of anchors installation

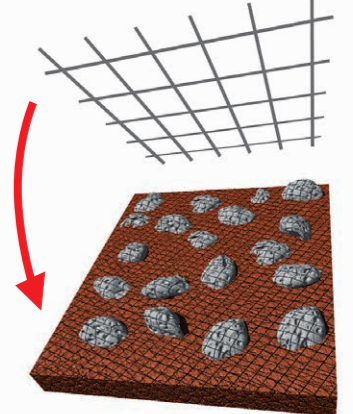

Stage 3

Vertical and horizontal wire ropes are netted along the slope.

Notice: Depending on the installation conditions, stage 2 and stage 3 can be held in the beginning of installation. Then a net installation follows.

Mighty Net standard design

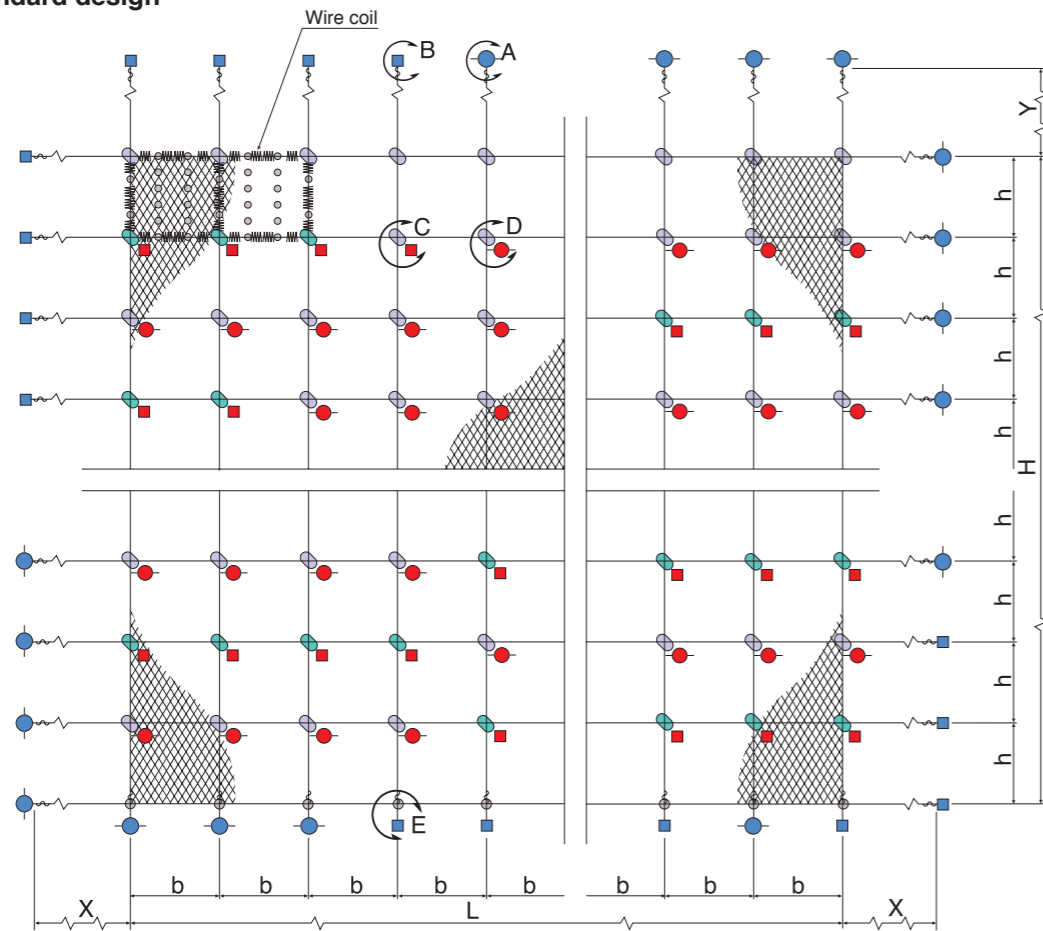

Element A

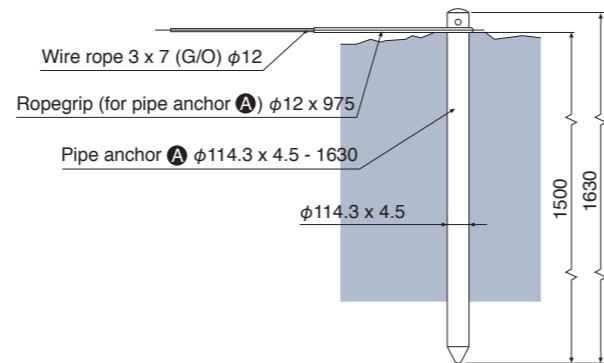
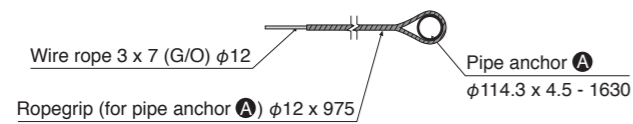

Detailed description of Mighty Net components

| Component name | Graphical symbol |
|-------------------------------------|-----------------------------|
| Thick netting | |
| Vertical rope | |
| Horizontal rope | |
| Ropegrip (for A type cement anchor) | |
| Ropegrip for pipe anchor | |
| Anchor | Cement anchor A (for rocks) |
| | Cement anchor B (for rocks) |
| | Pipe anchor A (for soil) |
| | Pipe anchor B (for soil) |
| Sub-anchor | Pin anchor |
| | Twisted anchor |
| Cross-shaped grip | |
| Cross-shaped anchor grip | |
| Cross clip | |
| Wire coil | |

Element B

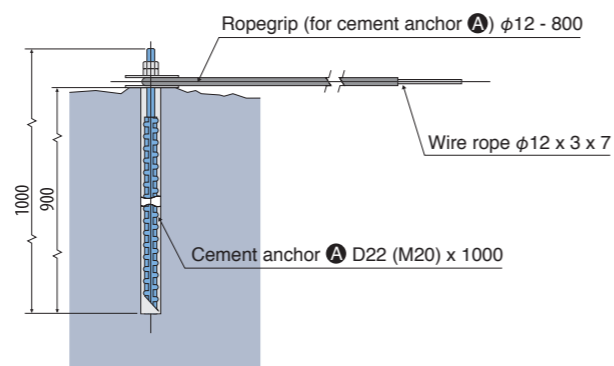

Elements C & D

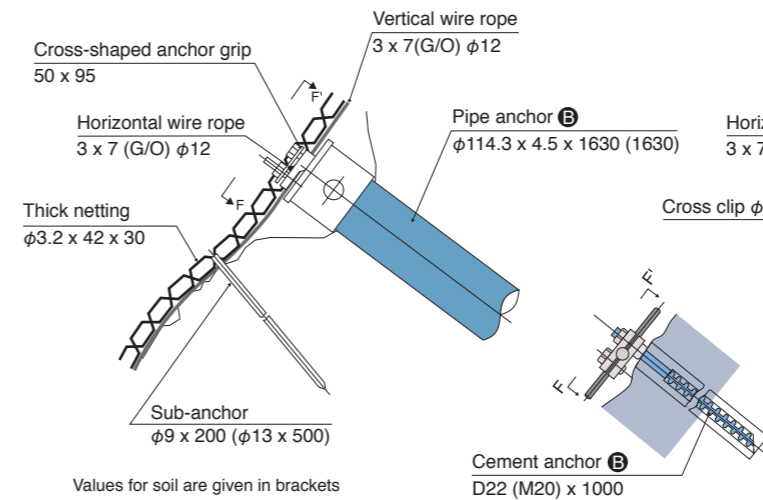

Element E

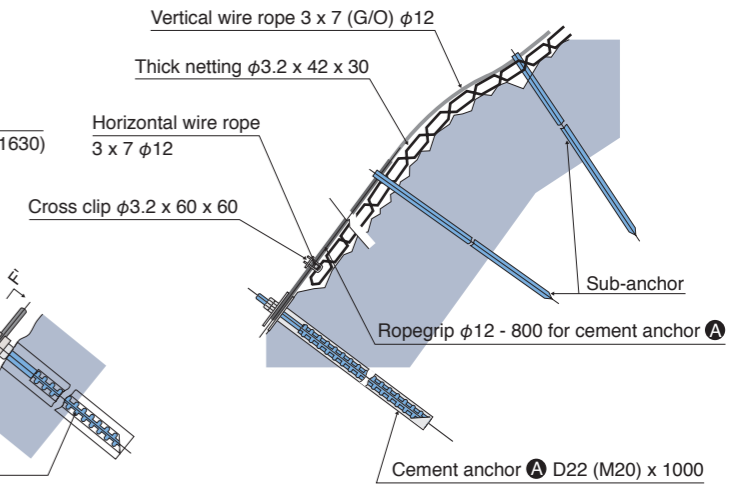

F-F' view from above

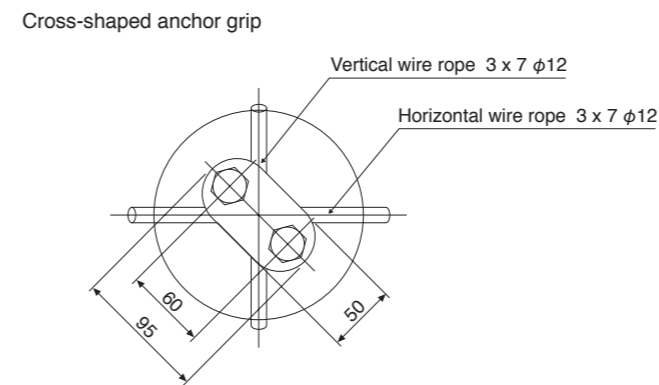

Ropegrip

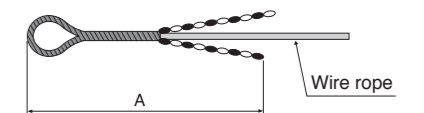

| Type | Wire rope diameter | A |
|---------------------|--------------------|-----|
| For cement anchor A | φ12 | 800 |
| For pipe anchor A | φ12 | 975 |

Wire coil

φ3.2 x 50 x 300 (φ3.2 x 70 x 300)

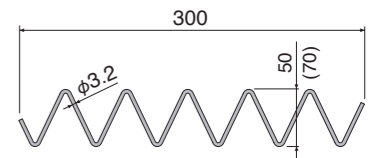

Thick netting

φ3.2 x 42 x 30 (φ3.2 x 46 x 50)

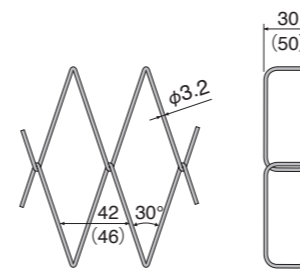

Pin anchor

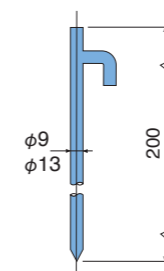

Twisted anchor

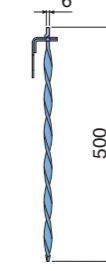

Required amount of pin anchors

| | |
|----------------------|---------------------------|
| Vertical wire rope | 2 pieces/2 m |
| Horizontal wire rope | 1 piece/1 m |
| Thick netting | 2 pieces/1 m ² |

Required amount of wire coils

| | |
|----------------------|--------------|
| Vertical wire rope | 1 piece/1 m |
| Horizontal wire rope | 2 pieces/1 m |
| Thick netting | 2 pieces/1 m |

Cross-shaped grip

